

LEWA ecodos®

High-quality diaphragm metering pumps
for low pressures



- hermetically tight
- low life cycle costs
- safe and reliable

For high requirements at low pressures: LEWA ecodos



The chemical industry:
LEWA ecodos pumps are used,
for example, for dosing of dye.



The petrochemical industry:
Used for gentle metering of highly
viscous fluids in the production of
biofuels, for example.

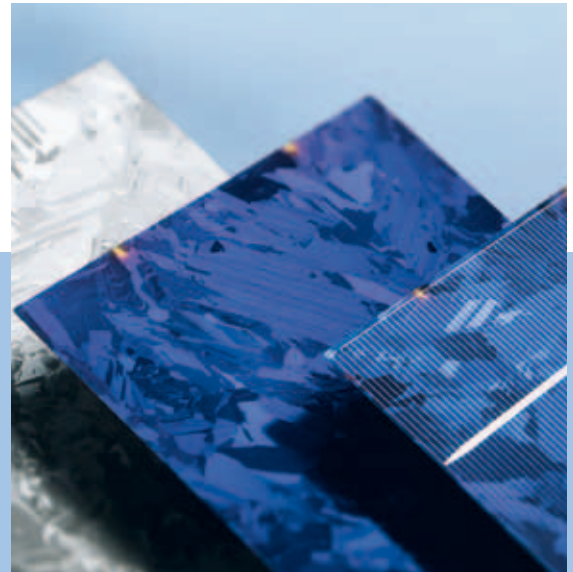

The plastics industry:
LEWA ecodos pumps are used, for example,
for polymerization processes in the manufacture
of solar cells.

Quality has never been so efficient and safe

LEWA ecodos diaphragm metering pumps are the ideal safe and efficient solution to meet all your specific metering and conveying application requirements in the low pressure range up to 20 bar (300 psig). Their performance ranges from 0.4 to 1,500 l/h (0.1-400 USgph) per pump head; and the pump heads can be simply combined to create multiplex pumps. The patented 4-layer PTFE sandwich-diaphragm provides increased safety and high-precision metering. Unique advantages which make the LEWA ecodos series stand out from its competitors:

- Hermetically tight diaphragm pump up to 20 bar (300 psig)
- Safe due to a 4-layer PTFE sandwich-diaphragm
- Integrated diaphragm monitoring system (as standard)
- Diaphragm service life of more than 16,000 operating hours
- Continued operation possible even if damages occur
- High metering accuracy: $\pm 1\%$
- Stainless steel, PVC or electrically conductive PTFE pump heads
- Unique: Available in 13 performance ratings, also as multiplex pumps
- Efficient: Low lifecycle costs



The pharmaceutical industry: LEWA ecodos in hygienic design meets the high demands of the pharmaceutical industry for extruding tablets, for example.



The cosmetics industry: LEWA ecodos in sanitary design guarantees problem-free cleaning in the manufacture of skin care products, for example.



The food industry: Sterile and reliable production, for manufacturing gelatin or fruit gums, for example.

Maximised performance and efficiency – in numerous sectors

With its flexible design, the LEWA ecodos series is ideal for a wide range of industrial applications; ranging from alcohol to suspensions. LEWA ecodos offers the highest precision, safety and reliability when handling emulsions or suspensions, alkalis or acids, paints or varnishes, cleaning agents or solvents, grease or oil, hazardous or toxic liquids. The LEWA ecodos series provides excellent and proven results in the following sectors:

- Chemical & biochemical
- Food & beverages
- Pharmaceutical & personal care
- Power plant engineering
- Mineral oil industry, Petrochemical industry
- Paper & pulp industry
- Environmental & process industry



For availability, safety and economic efficiency: LEWA ecodos technology

The availability and operational safety of your installations depends on the quality of the individual components. LEWA ecodos helps to increase availability.

With its cutting-edge design, the LEWA ecodos series exhibits numerous special diaphragm pump features. It is much more resistant than conventional diaphragm systems, more durable, highly pressure stiff and safer. LEWA ecodos has a much wider application range and is ideal for all types of fluids, solvents or diffusing fluids. Moreover, LEWA ecodos systems are hermetically tight – even with a damaged working diaphragm. This page provides an overview of the advantages.

Valves for various applications

Even the standard valve has reduced susceptibility to malfunction. Special valves are used for suspensions to ensure perfect operation.

4-layer safety diaphragm for complete tightness

- 2 working diaphragms
- 1 monitoring diaphragm
- 1 pressure-resistant safety diaphragm

Two working diaphragms result in double safety: If one is damaged, the other one continues to operate. If the second diaphragm is also faulty, it will be indicated by the monitoring diaphragm. The fourth pressure-resistant diaphragm ensures hermetical tightness; ensuring production is completed without risks.

PTFE for added resistance

PTFE is resistant to almost any fluid, e.g. solvents and diffusing fluids. It offers a greater application range and higher safety margins. Furthermore, it assures longer life cycles.

Longer diaphragm service life; more than 16,000 operating hours

LEWA ecodos safety diaphragms have a service life of more than 16,000 operating hours, i.e. two years of continuous operation. Therefore, the warranty period for diaphragms is two years.

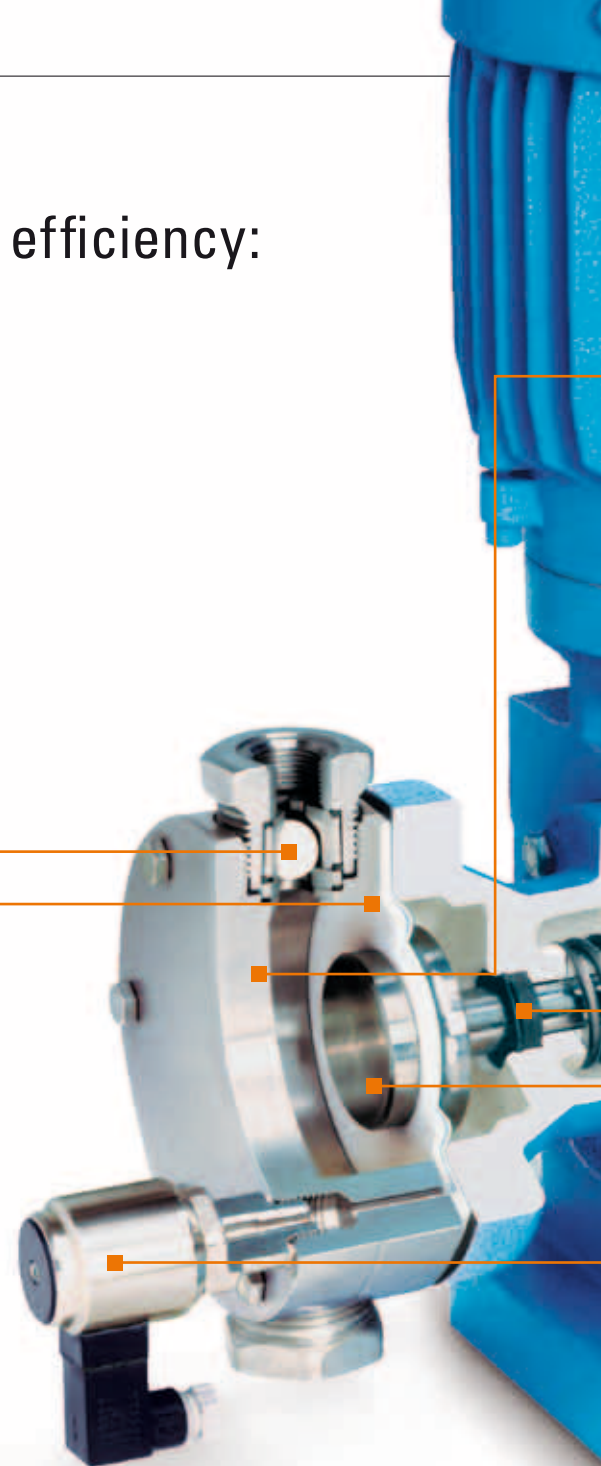

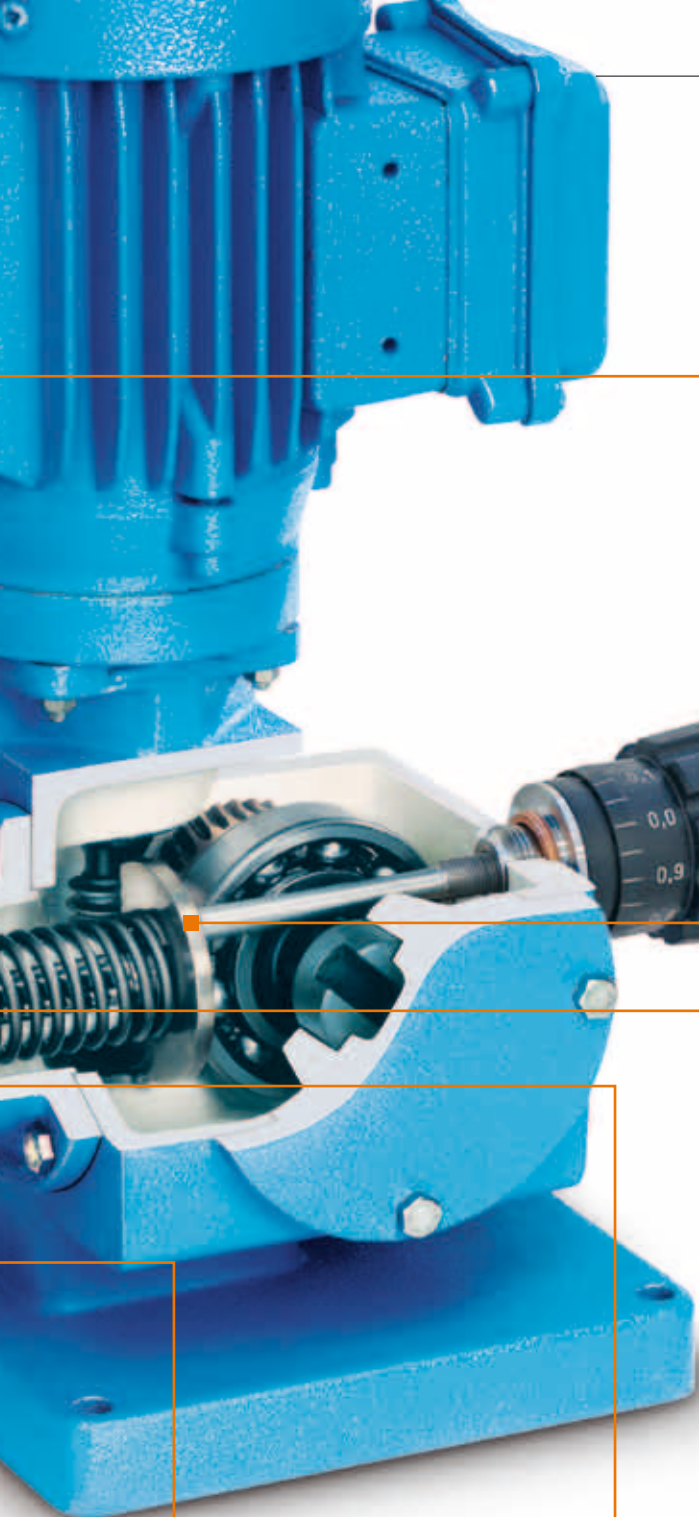

Photo: LEWA ecodos

The ideal material for each fluid

The standard material is stainless steel 1.4571(316Ti). Other materials are PVC, PVDF and electrically conductive PTFE.

High metering accuracy, gentle conveying

The metering pumps provide high metering accuracy and gentle conveying. Precise adjustment of the stroke (manually or electrically) and adjustment of the stroke frequency via a frequency inverter are possible. Reproducibility of the settings is better than $\pm 1\%$.

Robust drive units for continuous operation

The LEWA ecodos drive units are designed for continuous operation. Spring-cam drive units are used up to LEWA ecodos 550; variable eccentric drive units are used for higher performances.

Hermetically tight pump heads

The low-maintenance pump heads are hermetically tight. The diaphragm drive housing is sealed from the drive unit to prevent oil leakages when replacing a pump head.

Diaphragm monitoring system for increased safety

The pressure-controlled diaphragm monitoring system is integrated as standard. It reliably indicates damages immediately. Local and/or remote indication are/is possible via:

- a pressure switch (IE 4)
- a contact pressure gauge (similar to pressure switch but with a display)
- a pressure gauge
- hose nipples for uncritical fluids

Minimum dead spaces: shorter dwell period

The optimised construction of the pump head ensures that the amount of process fluid in the operating chamber is kept to a minimum. The design of the fluid passages results in perfect flushing, draining and drying procedures.

For optimum process adaptation: Various designs and options



Whether as a single pump,
e.g. with heads designed to be CIP/SIP.



Or as multiplex pumps,
e.g. for recipe metering



Or as feed pumps, e.g. for high
performance with low pulsation



Variable stroke setting:
electrical stroke adjustment EHV

LEWA ecodos series pumps are available in 13 performance ratings and can be combined to form multiplex pumps. The pump heads are constructed of stainless steel, PVC, PVDF or electrically conductive PTFE. With its individual controls and a complete range of accessories, LEWA ecodos can be adapted to any application. And it goes without saying that LEWA ecodos pumps meet all the specific demands of integration in automated installations.

High metering accuracy: $\pm 1\%$

LEWA ecodos diaphragm pumps are characterised by their extremely high metering accuracy. Flow rate fluctuations are less than $\pm 1\%$ in a stroke length adjustment range of 5:1.

Variable flow rate adjustment

Flow rates can be variably adjusted: the stroke length via a handwheel or actuator, the stroke frequency via a motor with frequency inverter. The recommended adjustment range via the stroke length is 5:1 and can be additionally extended via the stroke frequency.

Precise stroke adjustment: manually or electrically

Stroke adjustments are operator friendly and display the precise stroke length via:

- Manual stroke adjustment
- Electrical stroke adjustment with stroke length adjustment signal and end position cut-off up to LEWA ecodos 350 with integrated positioner, guide signal and 4-20 mA (factory setting), optional 0-20 mA
- LEWA ecodos 750 and higher with electrical stroke adjustment, emergency operation via a handwheel is also possible

Precise speed adjustment via frequency inverter

The adjustment range can be easily extended via a frequency inverter. Inverter and pump are supplied function tested; eliminating the need for complex optimisation and parameterisation. LEWA also supplies complete control cabinets on demand:

- Frequency inverter for motor power of 0.37–7.5 kW
- Designed as 1-phase or 3-phase devices



Perfect stroke frequency:
LEWA ecodos with frequency inverter



Drive options

The drives are IEC motors of well-known manufacturers. The following drives are fitted as standard:

- 3-phase motors 230/400V 50Hz or 460V 60Hz
- Degree of protection IP55, insulation class F
- Optionally with protection class EExe IIT3 and EExde IICT4

Further motors, voltages and degrees of protection available on request.

Valve options

Various insert rings for the valve seats of the stainless steel pump heads are available to ensure perfect adaptation to the fluid.

- PTFE
- FPM
- Polyurethane
- Valve seats made of hardened 1.4122

Control options

LEWA supplies complete controls, e.g. for proportional or batch metering. We will provide you with detailed information on request.

Instrumentation options

The contactors are installed at the last drive element and determine the number of pump strokes, e.g. for batch control and totaliser.

- Inductive proximity switch according to NAMUR (DIN19234)
- Explosion protection Exi
- Degree of protection IP65



Field-proven controls:
e.g. for proportional or batch metering

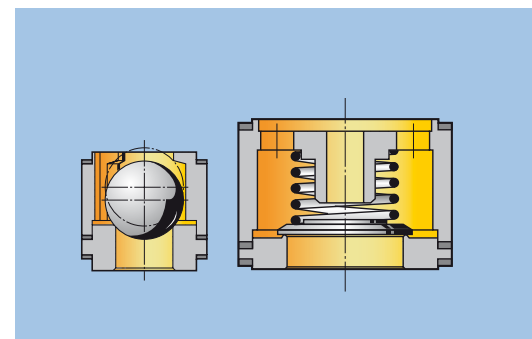

Low wear valves for various applications

For extra production safety: LEWA ecodos accessories

Intelligent accessories make the most of your application or plant.

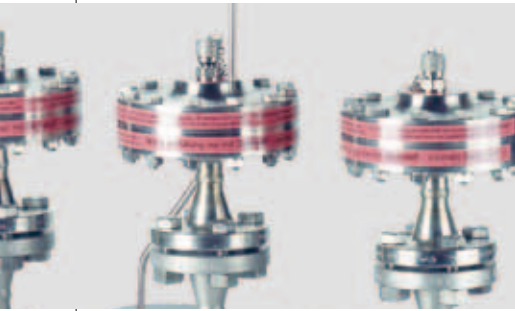

Pulsation dampers

Pulsation dampers

Metering pumps work in pulses; on each pump stroke, fluid is accelerated and then decelerated. Pulsation dampers can be required for two reasons:

- To reduce excessively high pressure fluctuations
- To generate a flow rate that is almost continuous

LEWA has the expertise as well as the accessories to optimally tailor pumps and installations to one another.



Safety valve

Safety valves

LEWA safety valves prevent pressure overloads in the pumps and installation. Metering pumps, which deliver by force, must always be protected with a safety valve if there is a risk that the discharge pipe could close during operation of the pump (e.g. by sedimentation in the pipe).

Further options

Further accessories (e.g. injection points, DIN and ANSI flanges or wear parts kits) are also available on request.

Strainers

Many fluids being conveyed contain impurities. These can lead to faults in the metering pump valves – from slight fluctuations in the metered flow to complete failure. In order to reliably avoid these effects, LEWA recommends fitting strainers in the suction pipelines.

Pressure retaining valves

LEWA pressure retaining valves prevent uncontrolled flow through the pumps (excessive delivery). This occurs when the pressure on the suction flange is greater than on the discharge flange, which can be caused either statically or dynamically. The retaining pressures are generally low.

Expert installation

Let LEWA advise you on matters of pump design and expert installation. We are also happy to supply you with a fully-functional system or offer suitable components or a finished installation with suction and discharge pipe line.



Expert installation

A quick overview: Technical data for the LEWA ecodos

LEWA ecodos – Technical data

Type/ Flow rate eff. (Qmax at pmax)	2	4	6	12	25	50	90	180	350	550	750	1100	1500	l/h	
Stroke frequency at 50 Hz	27	54	80	160	80	160	80	160	160	145	113	170	228	min -1	
Performance, simplex pump	0,18	0,25	0,18	0,25	0,18	0,25	0,37	0,55	0,55	0,75	0,75	1,5	1,5	kW	
Approx. weight (simplex incl. motor)	15	15	15	15	15	15	23	23	30	60	76	76	76	kg	
Version S, stainless steel 1.4571 (316Ti) pump head															
Operating pressure	20	20	20	20	10	10	10	10	7,5	7,5	5	5	5	bar	
Permissible operating temperature	-10/+80													°C	
Valve type	Ball valve											Plates			
Standard connections	G3/8" FT							G1/2" FT	DN25PN40 flanges						
Optional connections	Dairy pipe screw joint, Triclamp, DIN + ANSI flanges														
Version P, PVC-H pump head															
Operating pressure	12	12	12	12	10	10	10	10	7,5	7,5	5	5	5	bar	
Permissible operating temperature	0/+60													°C	
Valve type	Ball valve											Plates**			
Standard connections	Hose/Bushing Ø 12				Hose/Bushing Ø 20				DN25PN40 flanges						
Optional connections	DIN + ANSI flanges														
Version F, PVDF fluorinated plastic pump head															
Arbeitsdruck	12	12	12	12	10	10	10	10	7,5	7,5	5	5	5	bar	
Permissible operating temperature	-10/+80													°C	
Valve type	Ball valve											Plates**			
Standard connections	G3/8" FT						Hose/Bushing Ø 20			DN25PN40 flanges					
Optional connections	DIN + ANSI flanges														
PTFE sandwich-diaphragm Ball valves with oxide ceramic ball, Gylon or PTFE seal rings ** Hastelloy valve springs FT = female thread															

LEWA ecodos – Assembly dimensions

LEWA ecodos type	L [mm]	B [mm]	ΔB [mm]	H [mm]
2 - 50	360	220	85	480
90 - 350	425	220	120	570
550	595	270	175	660
750 - 1500*1	500	400	–	800
750 - 1500*2	500	900	250	450

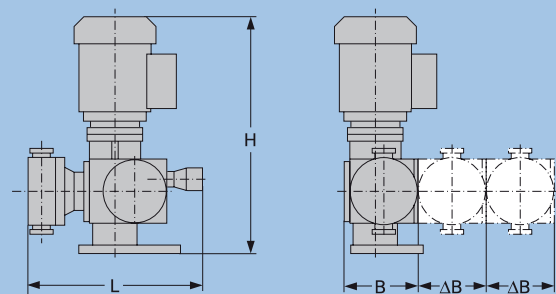

*1 = Vertical motor assembly

*2 = Horizontal motor assembly (for multiplex pumps or simplex pumps with attachments)
(electrical stroke actuator and /or contactor)

The dimensions differ depending on the fitted pump head, the motor and the instrumentation

For every occasion: The LEWA product range

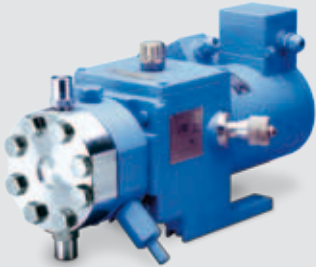

LEWA micro-flow metering pumps

For laboratories & pilot plants: LEWA micro-flow pumps

These micro-flow metering pumps with hydraulically actuated metal diaphragms are primarily used in laboratories and for test procedures in pilot plants.

Performance range

Flow rate	up to 0.04 m ³ /h
Discharge pressure	up to 560 bar



LEWA ecoflow

For medium to high pressures: LEWA ecoflow metering pumps

LEWA ecoflow offers the most advanced, safe, leak-free metering pumps for medium and high pressures.

Performance range

Flow rate	up to 10 m ³ /h per pump head
Discharge pressure	up to 1,200 bar



LEWA triplex process diaphragm pumps

For sterile applications: LEWA Sanitary & Hygienic

LEWA supplies special sanitary and hygienic diaphragm pumps for metering tasks in hygienic, aseptic or sterile procedures, whether for food and beverages or for pharmaceuticals and personal care.

Performance range

Flow rate	up to 4.5 m ³ /h per pump head
Discharge pressure	up to 350 bar



LEWA metering systems
and chemical injection packages

For more information, please request our individual brochures.

For high pressures: LEWA process diaphragm pumps

The leak-free LEWA process diaphragm pumps for high flow rates are the tightness standard in high-pressure process technology. Using LEWA triplex process diaphragm pumps, even critical, toxic or flammable liquids can be conveyed safely. Even extremely low viscous, non-lubricating fluids or abrasive suspensions can be handled successfully.

Performance range

Flow rate	up to 180 m ³ /h
Discharge pressure	up to 1,200 bar

For closed control loops: LEWA metering systems

LEWA is the first point of contact in the market for high-performance yet economically designed metering systems. These are modular combinations of pumps, valves and controls for stroke length and speed, flow meters (volume or mass flow) and controllers. The metered flow is adjusted in a closed control loop.

For process automation: LEWA metering packages

LEWA metering and mixing packages for process automation are available either as standard variants ready for connection, or designed by LEWA specifically for the customer's request. LEWA can supply complete, ready to operate problem solutions. Our services range from engineering to commissioning – including individual package controls, process visualisation, logging of operational data and external interfaces to the process guiding system.

For the highest demands: LEWA engineering & services



Profit from LEWA's expertise during the planning stage, the design and during operation.

Consultancy & engineering for particular requirements

With over 10,000 successful applications, LEWA has a very wide range of application expertise around the world. Profit from our experience. We see ourselves as a supplier of solutions and systems for any application involving the conveying, metering and mixing of gases and liquids. We can thus provide tailor-made solutions, from the smallest single unit to the largest inline installations, as well as process engineering consultancy for complex processes. Solutions that meet particular process requirements.

- Fluid assessment
- Installation calculations
- Individually designed concepts
- Commissioning and service
- Seminars and on-site trainings

Global service network for greater availability

LEWA follows its customers around the world. With numerous subsidiaries and authorized agencies, you will find us in all major countries. This local presence is also critical for the successful implementation of international projects. Regular maintenance guarantees the reliability and, particularly, the profitability of a pump system. This is where we can help out with our comprehensive expertise. We look after LEWA installations – worldwide. And we ensure that original spare parts can be supplied and will remain available for many years.



Always close to site: whether for consultancy, maintenance or servicing, local presence takes top priority at LEWA.



For the toughest environments: High levels of reliability even when used under harsh conditions.

LEWA proven services and technologies

Germany / Headquarters

LEWA GmbH

Ulmer Str. 10
71229 Leonberg
Phone +49 7152 14-0
Fax +49 7152 14-1303
lewa@lewa.de
www.lewa.de

Japan / Headquarters

NIKKISO CO. LTD.

Yebisu Garden Place Tower 22nd Floor
20-3, Ebisu 4-Chome, Shibuya-ku
Tokyo 150-6022
Phone +81 3 3443-3711
Fax +81 3 3473-4963
www.nikkiso.com



Contacts of LEWA's numerous affiliated companies and representatives can be found on

www.lewa.com



Customized solutions for metering and process technology

For more than 50 years, LEWA has set the technical trends of metering pumps and systems. LEWA offers a single-source solution to handling complex metering and mixing tasks – ranging from individual pump configuration, basic and detailed system engineering and pretesting to onsite commissioning and maintenance services.

Good causes to rely on:

- A solution for your special application: from process analysis to global service
- Highest process safety: individual pump configuration and state-of-the-art design
- International engineering and project competencies
- Highest reliability: developed for continuous operation
- Low lifetime costs: reduced energy consumption and low-wear design
- Compliance with international standards, e.g. API, ASME, GOSTR, FDA, EHEDG, 3A, TÜV
- Comprehensive reference list

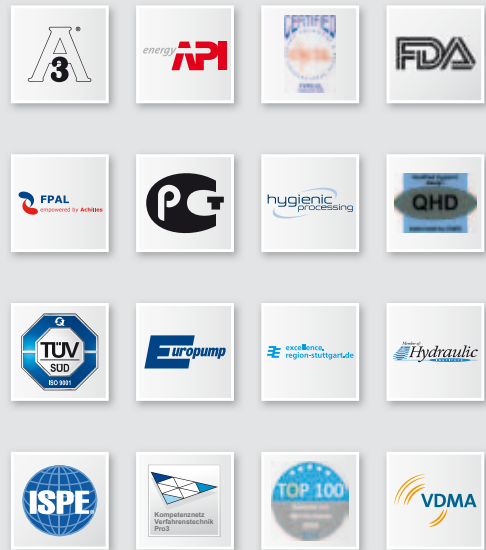

Areas of expertise:



Oil & Gas



Chemicals & Petrochemicals



Pharma & Biotech



Personal Care



Food & Beverages



Plastics



Cleaning & Detergents



Energy & Environment



Gas Odorization

Your local representative:

